

A detailed technical line drawing of a hydraulic vane pump, showing the internal rotor and vanes within a circular housing. The drawing is rendered in a dark grey color against a black background.

# FIXED DISPLACEMENT HYDRAULIC VANE PUMPS SERIE BV

 **B&C**  
HYDRAULICS



## FIXED DISPLACEMENT HYDRAULIC VANE PUMPS “BV” SERIES

Versatility, power, compactness and low running costs are the main characteristics of B&C vane pumps. All the components subject to wear are contained in a cartridge unit that can be easily removed for inspection and/or replacement without disconnecting the pump from the circuit, drastically reducing expensive machine down time.

The cartridge contains a rotor, vanes and inserts, a cam ring and two covers. During operation the rotor is driven by a splined shaft coupled to the drive unit. As the rotation speed increases, centrifugal forces, in combination with the pressure generated behind the vanes, push the vanes outwards, where they follow the profile of the cam of the ring with a sufficient contact pressure to ensure adequate hydraulic sealing. The two opposed pumping chambers formed by the elliptical profile of the cam cancel out radial loads on the shaft bearings, thereby giving them extremely long lifetimes.

The versatility of the BV series pumps enables them to meet the requirements of the most varied industrial applications. In fact, as well as their proven high reliability and excellent volumetric efficiency in all working conditions, they operate with particularly low noise levels. This is made possible by the special profile of the cam ring and the use of a 12 vane rotor that reduces the amplitude of the supply pressure pulses, thereby reducing induced vibrations (see drawing).

The BV series is available in four versions of single pump (from 8 to 230 l/min at 1200 rpm) and six versions of double pump (from 55 to 370 l/min at 1200 rpm), with maximum powers of over 300 HP. The BV series pumps are extremely compact and are supplied with ISO norm mechanical couplings and SAE norm hydraulic fittings. This makes them very easy to install and guarantees their interchangeability with other similar pumps.

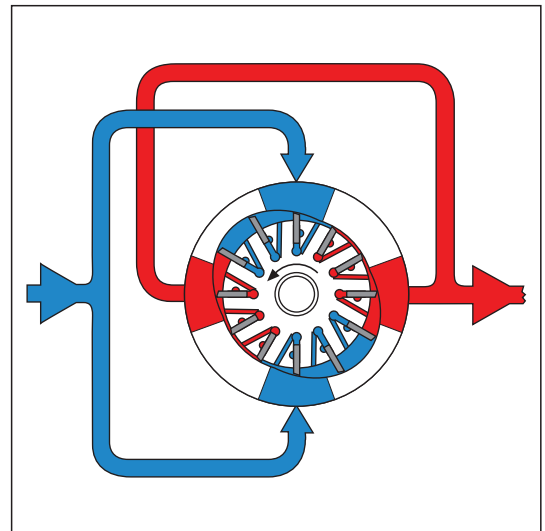

# double pump BV42

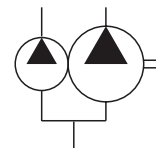
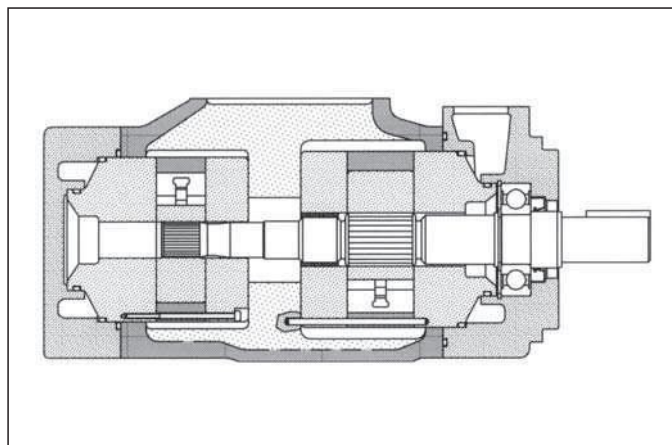

## General description

Fixed displacement vane pump, hydraulically balanced, with capacity determined by the cartridges used and the speed of rotation. The pump is available in several versions with rated capacities from 127 to 219 l/min (from 33 to 59 gpm) at 1200 rpm and 7 bar.

## Technical characteristics

Cartridge model	Geometric displacement		Rated capacity at 1200 rpm 7 bar		Rated capacity at 1500 rpm 7 bar		Maximum pressure with mineral oil		Speed range rpm	
	cm <sup>3</sup> /g	(in <sup>3</sup> /r)	l/min	(gpm)	l/min	(gpm)	bar	(psi)	min	max
<b>shaft end</b>										
V04-21	69,0	(4.2)	79,5	(21)	101,4	(26.8)	175	(2538)	600	1800
V04-25	81,6	(5)	94,0	(25)	120,1	(31.7)	175	(2538)	600	1800
V04-30	97,7	(6)	113,8	(30)	141,2	(37.3)	175	(2538)	600	1800
V04-35	112,7	(6.9)	131,6	(35)	167,2	(44.1)	175	(2538)	600	1800
V04-38	121,6	(7.4)	139,9	(38)	177,3	(46.8)	175	(2538)	600	1800
<b>cover end</b>										
V02-12	40,1	(2.45)	46,9	(12)	58,8	(15.5)	175	(2538)	600	1800
V02-14	45,4	(2.77)	52,7	(14)	65,7	(17.4)	175	(2538)	600	1800
V02-17	55,2	(3.37)	64,2	(17)	80,2	(21.2)	175	(2538)	600	1800
V02-19	60,0	(3.66)	71,0	(19)	88,7	(23.4)	175	(2538)	600	1800
V02-21	67,5	(4.12)	79,0	(21)	99,8	(26.4)	175	(2538)	600	1800

**Hydraulic fluids:** antiwear high quality mineral oils or fire resistant fluid having same lubrication capacities of the mineral oil.

**Viscosity range (with mineral oil):** from 13 to 860 cSt. (13 to 54 cSt. recommended).

**Filtration:** for the inlet - 149 micron abs., for the return line - 25 micron abs. or better (with synthetic fluids: for the return line - 10 micron abs. or better).

**Inlet pressure:** (with mineral oil): from -0,17 to +1,4 bar (-2.5 to + 20 psi)

**Operating temperature:** with mineral oil -10°C +70°C (+30°C to +60°C recommended), with water based fluids +15°C to +50°C.

**Drive:** direct and coaxial by means of a flexible coupling.

## Main operating data

max pressure / hydraulic fluid

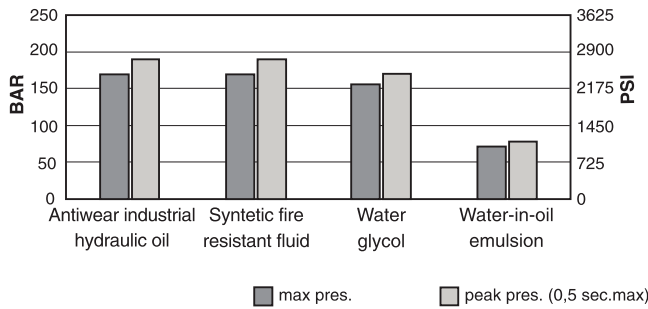

max speed / hydraulic fluid (with 0 bar in the intake pipe)

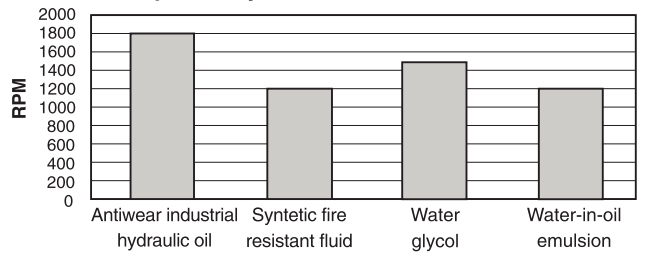

If the intake pressure is not zero bar, use the graph below to find the percentage correction factor to apply to the maximum speed

max speed / intake pipe pressure

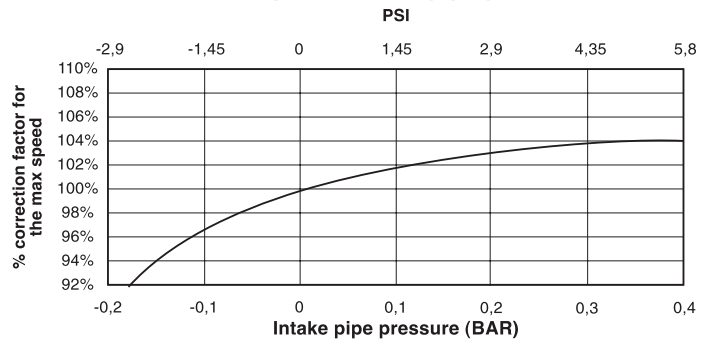

Sound level at 138 bar (2000 psi)

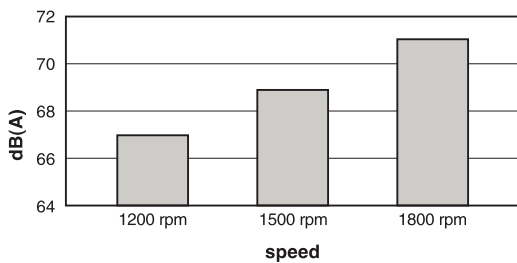

flow / pressure

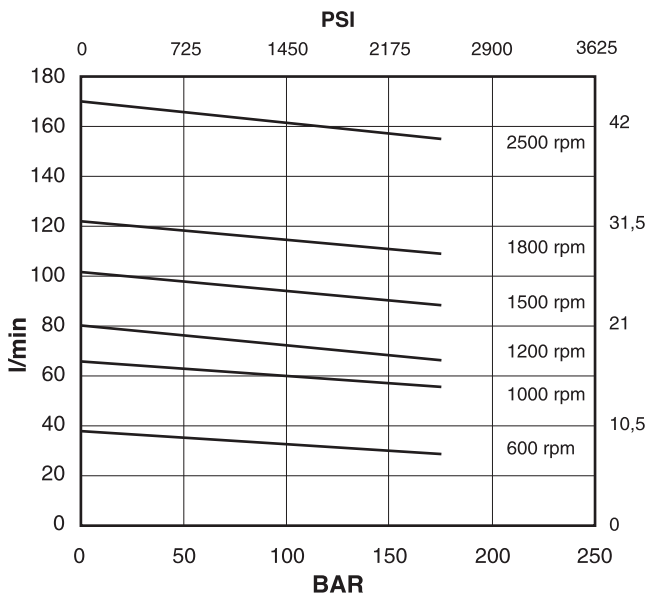

Shaft end cartridge V04-21

power / pressure

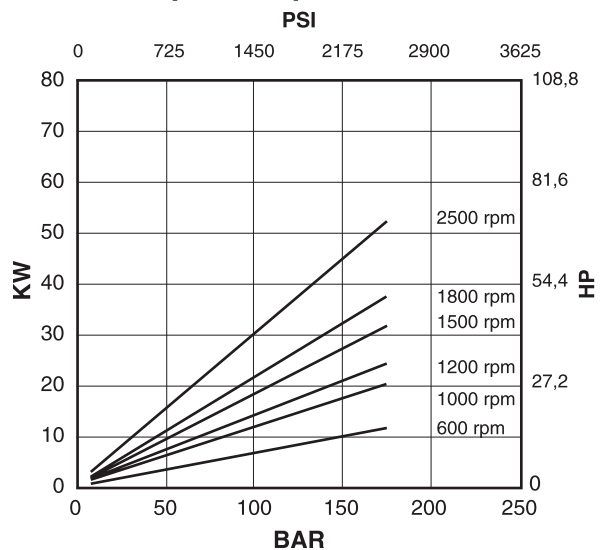

input torque / pressure

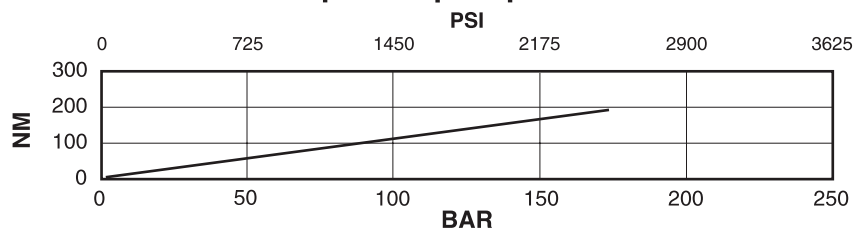

Oil viscosity: 25 c.St.(10W)  
Temperature: 45°C  
Inlet pressure: 0 BAR

## Shaft end cartridge V04-25

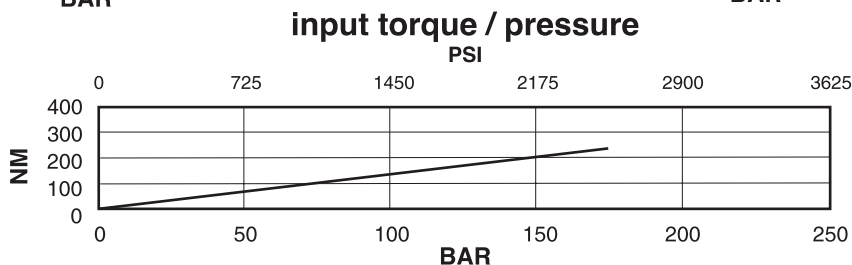
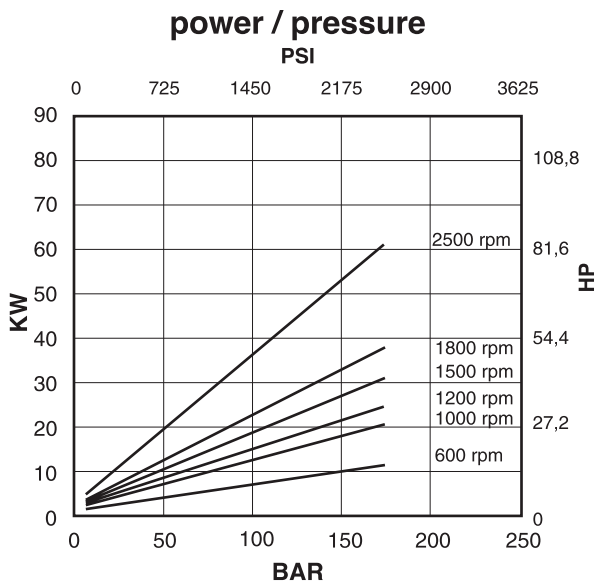
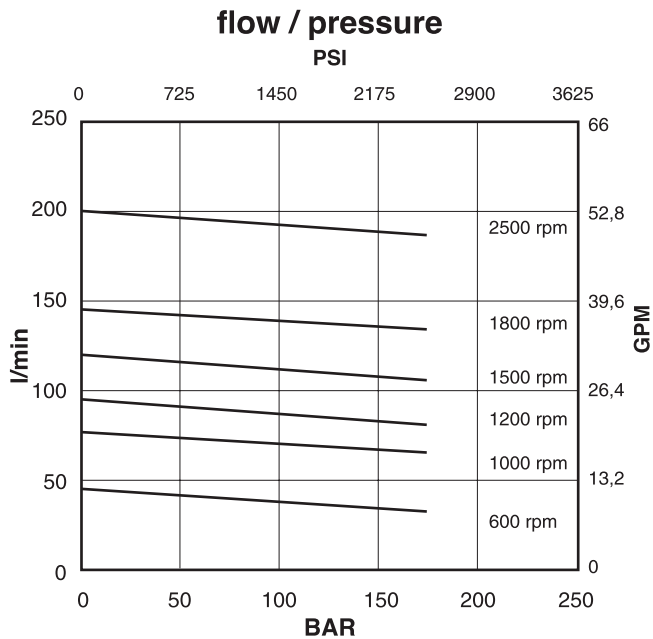

Oil viscosity: 25 c.St.(10W)  
Temperature: 45°C  
Inlet pressure: 0 BAR

## Shaft end cartridge V04-30

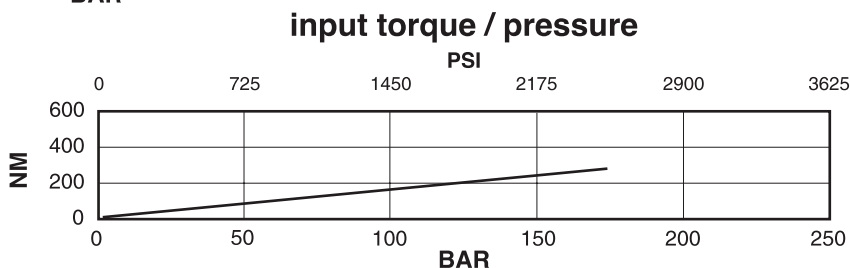
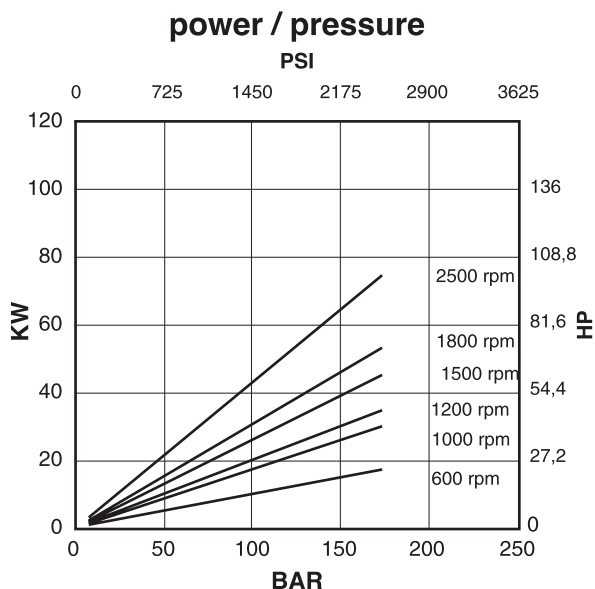
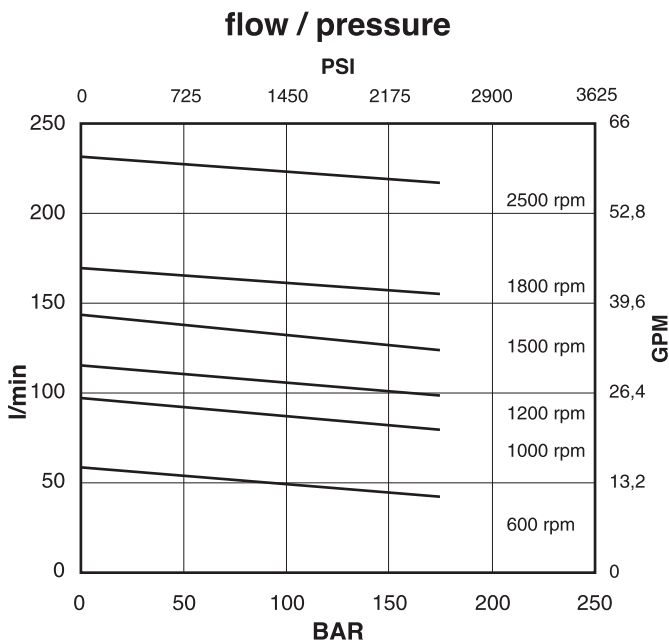

Oil viscosity: 25 c.St.(10W)  
Temperature: 45°C  
Inlet pressure: 0 BAR

# double pump BV42

## Shaft end cartridge V04-35

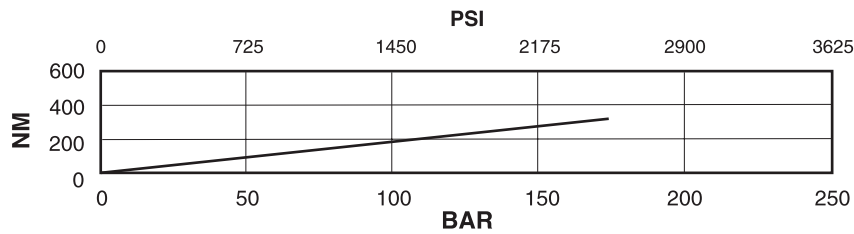
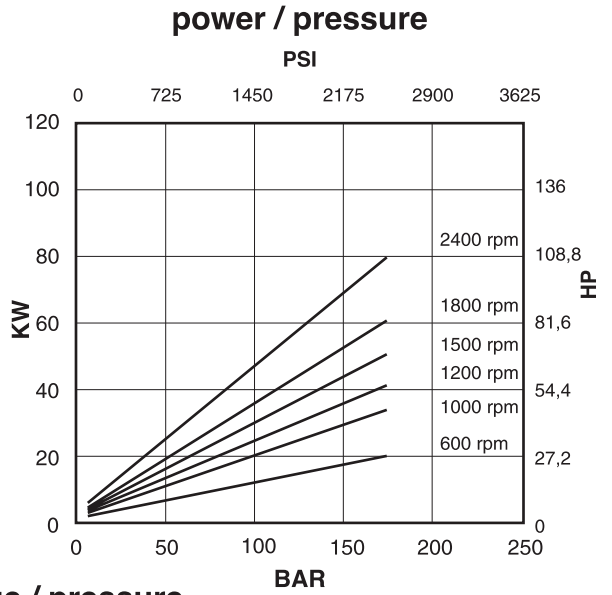
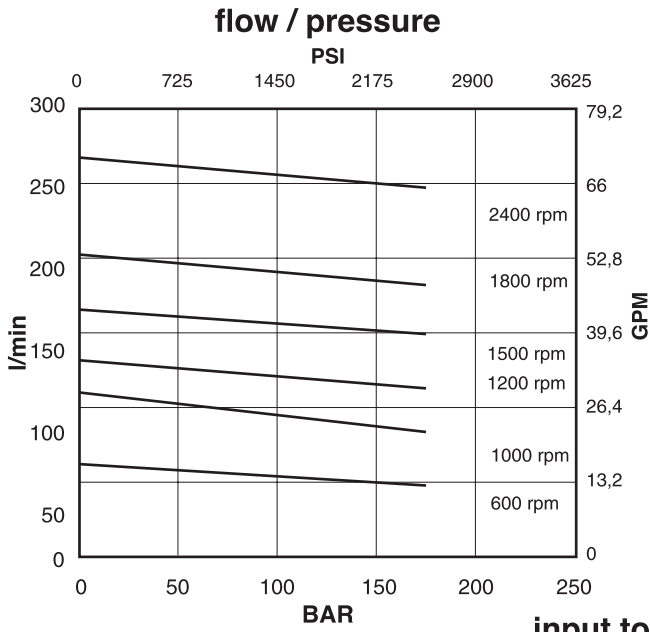

Oil viscosity: 25 c.St.(10W)  
 Temperature: 45°C  
 Inlet pressure: 0 BAR

## Shaft end cartridge V04-38

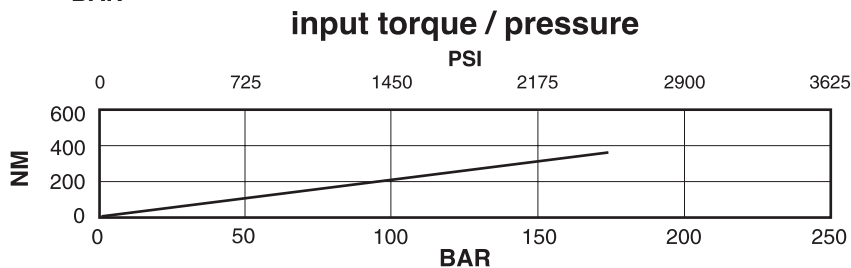
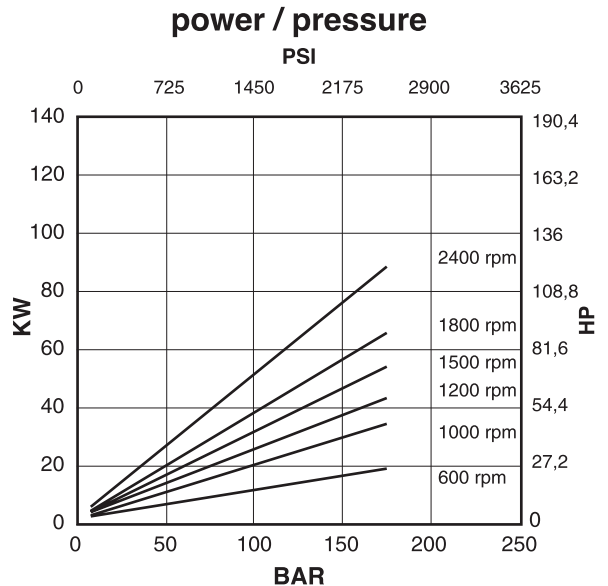
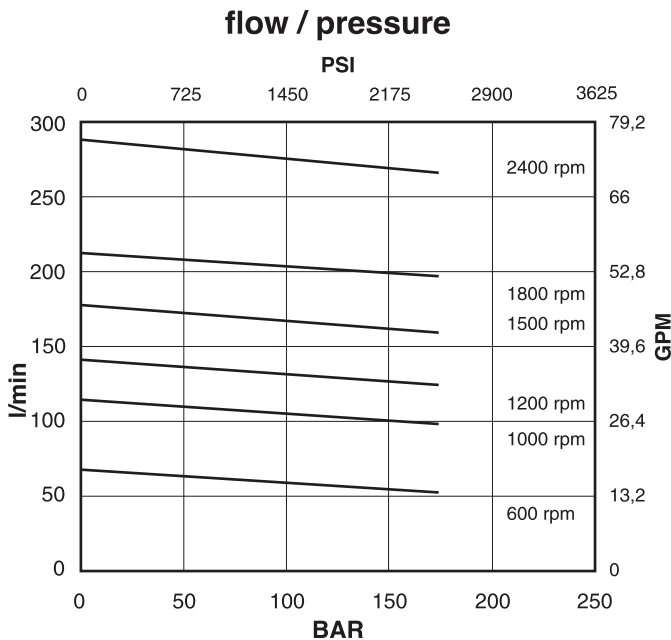

Oil viscosity: 25 c.St.(10W)  
 Temperature: 45°C  
 Inlet pressure: 0 BAR

# double pump BV42

## Cover end cartridge V02-12

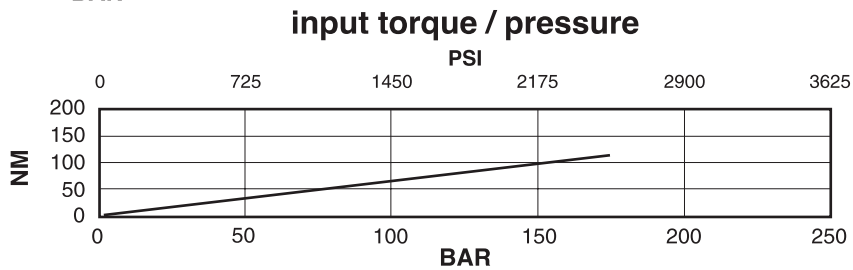
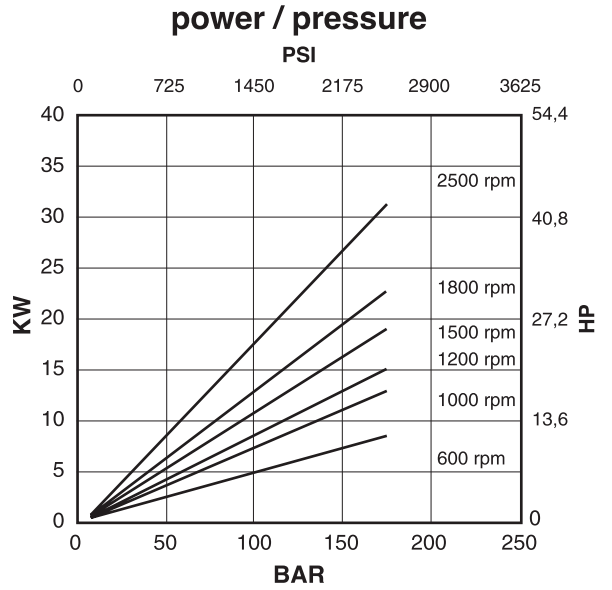
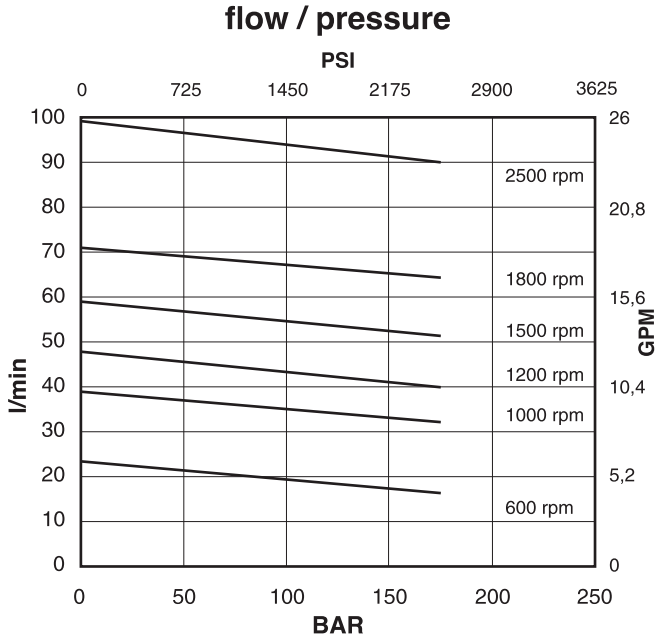

Oil viscosity: 25 c.St.(10W)  
 Temperature: 45°C  
 Inlet pressure: 0 BAR

## Cover end cartridge V02-14

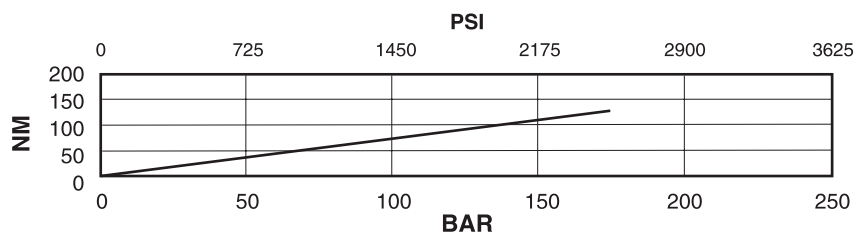
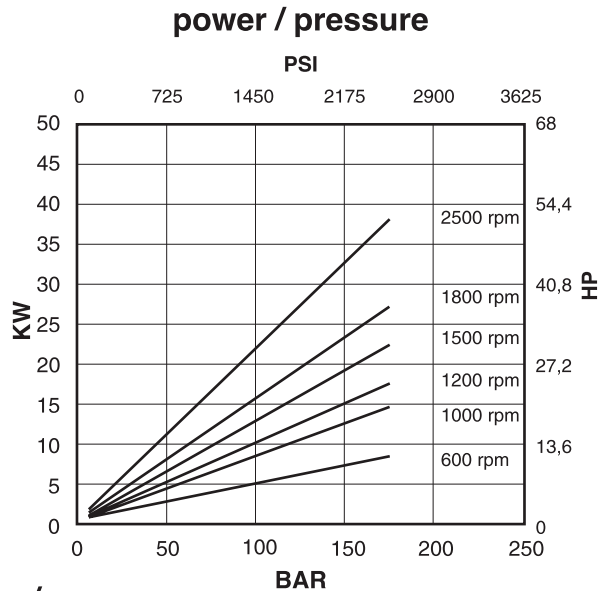
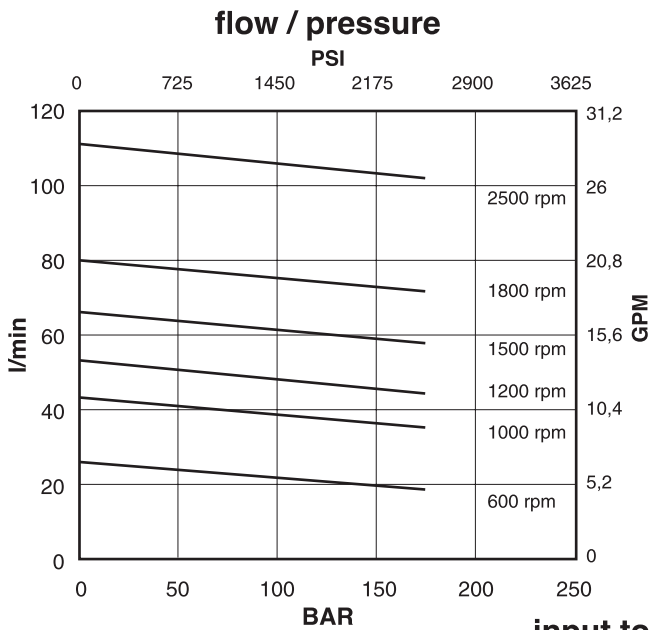

Oil viscosity: 25 c.St.(10W)  
 Temperature: 45°C  
 Inlet pressure: 0 BAR

# double pump BV42

## Cover end cartridge V02-17

flow / pressure

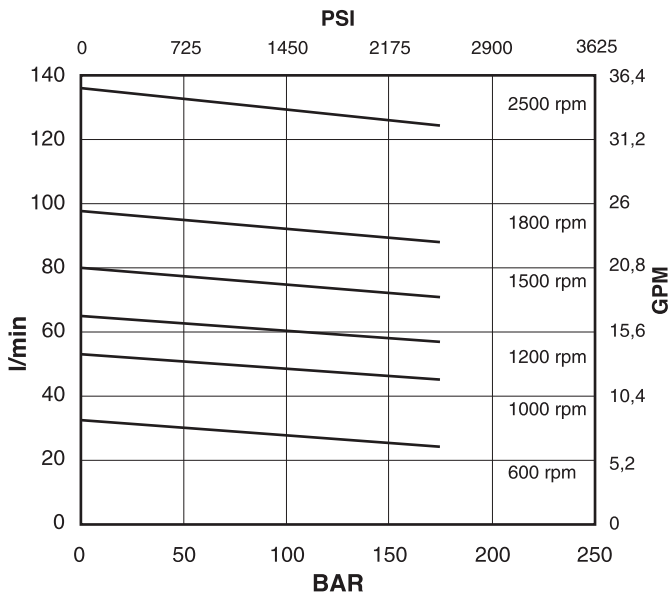

power / pressure

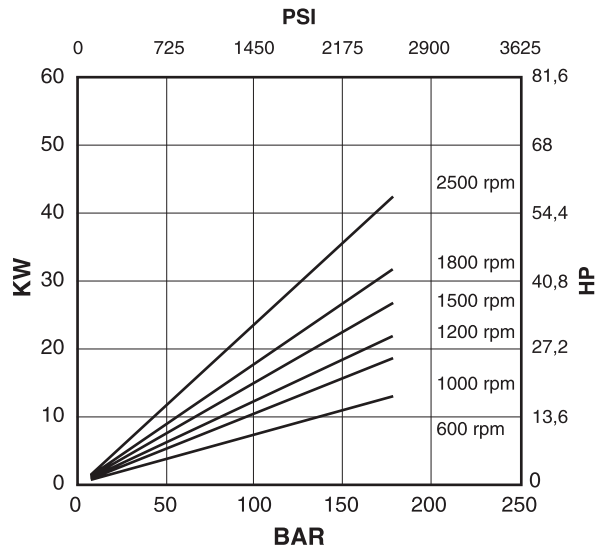

input torque / pressure

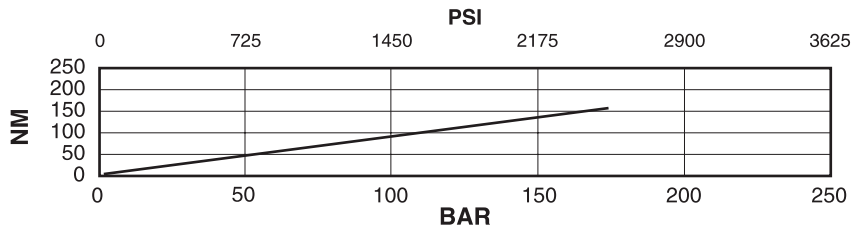

Oil viscosity: 25 c.St.(10W)  
Temperature: 45°C  
Inlet pressure: 0 BAR

## Cover end cartridge V02-19

flow / pressure

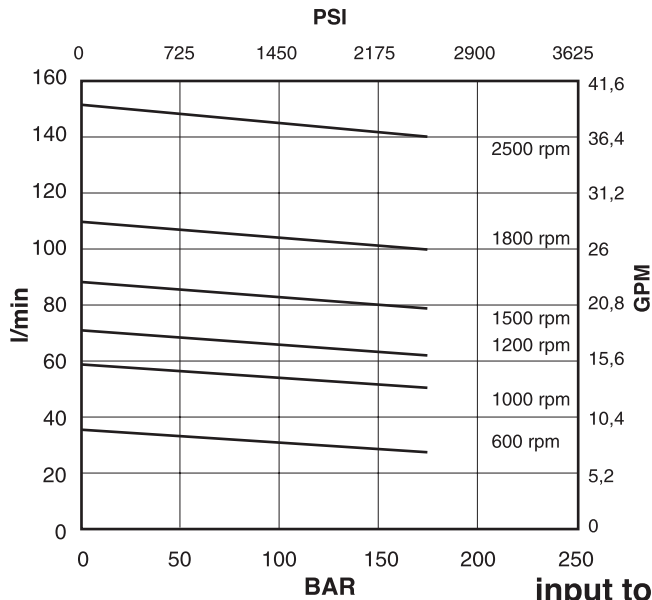

power / pressure

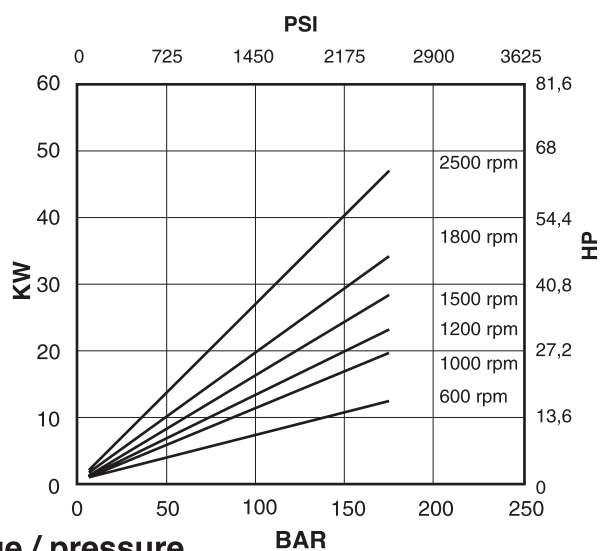

input torque / pressure

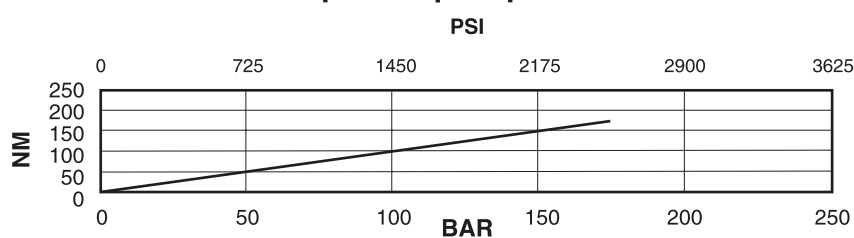

Oil viscosity: 25 c.St.(10W)  
Temperature: 45°C  
Inlet pressure: 0 BAR



# double pump BV42

## Cover end cartridge V02-21

### flow / pressure

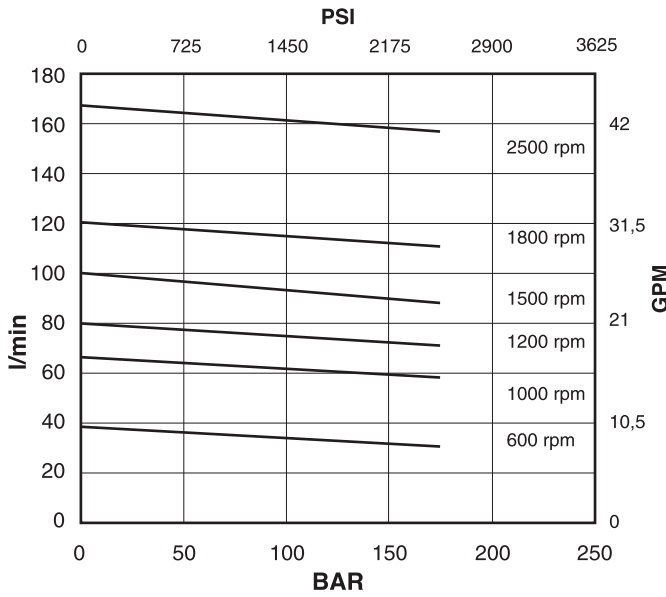

### power / pressure

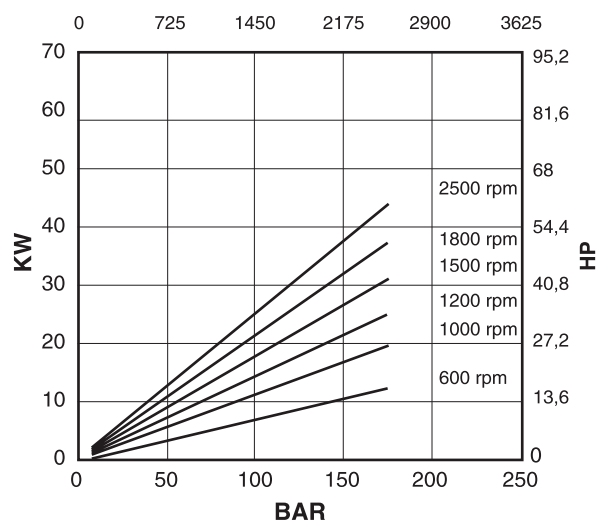

### input torque / pressure

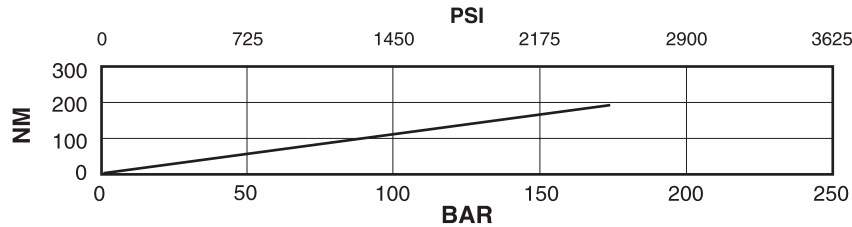

Oil viscosity: 25 c.St.(10W)  
Temperature: 45°C  
Inlet pressure: 0 BAR

## Installation dimensions mm (inches)

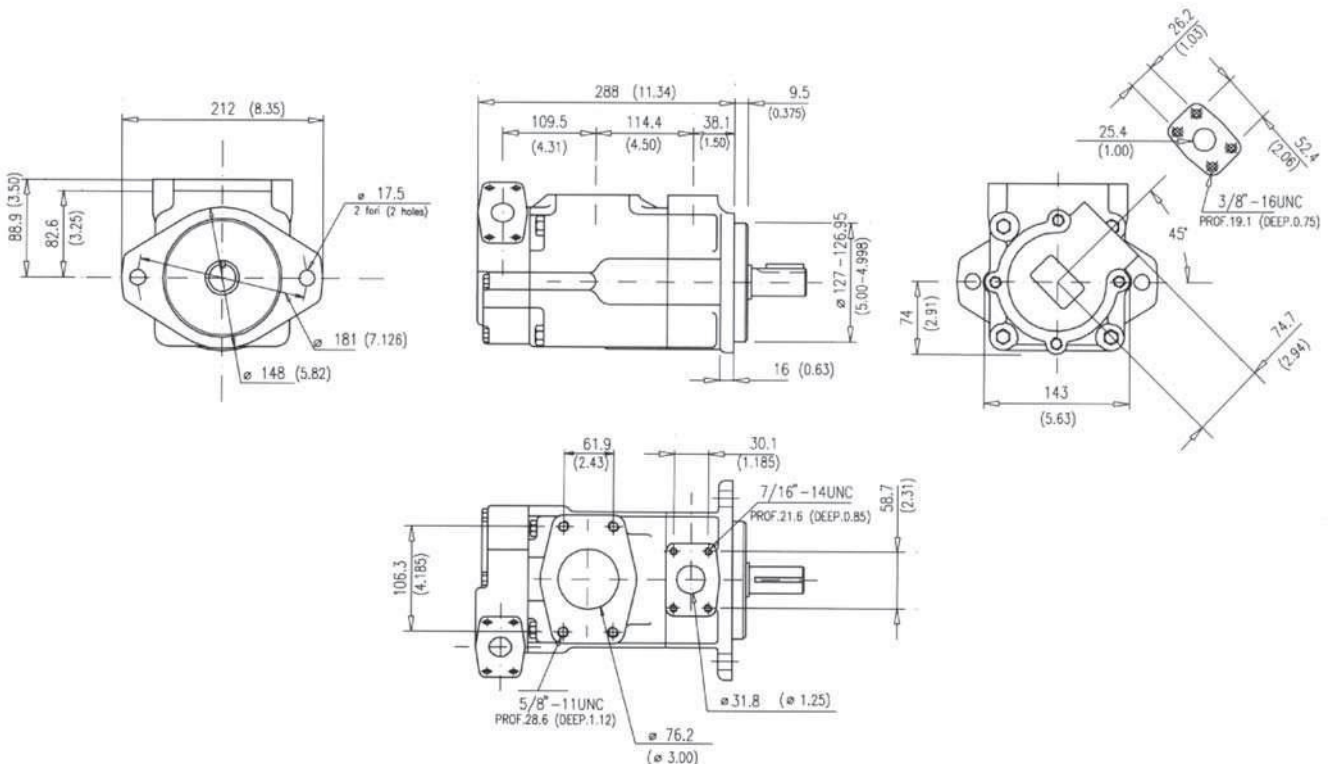

Approx. weight: 34,5 Kg. (76 lbs.)

## Model code breakdown

<b>BV</b>	<b>42</b>	<b>G</b>	<b>**</b>	<b>**</b>	<b>*</b>	<b>*</b>	<b>**</b>	<b>(L)</b>	<b>*</b>	<b>(A)</b>
Pump series		Design								Mounting (omit if not required)
Pump type										Seals (omit with standard seals and one shaft-seal in NBR) <b>V</b> = seals and shaft-seal in FPM (Viton®) <b>D</b> = standard seals and double shaft-seals in NBR <b>F</b> = seals and double shaft-seals in FPM (Viton®)
Cartridge types										Rotation (viewed from shaft end) <b>L</b> = left hand rotation CCW (omit if CW)
-shaft end 21 25 30 35 38										
-cover end 12 14 17 19 21										
Body outlet port positions (outlet viewed from cover end)										
A = Outlet opposite end										
B = Outlet 90° CCW from inlet										
C = Outlet in line with inlet										
D = Outlet 90° CW from inlet										
Cover outlet port positions (outlet viewed from cover end)										
A = Outlet 135° CCW from inlet										
B = Outlet 45° CCW from inlet										
C = Outlet 45° CW from inlet										
D = Outlet 135° CW from inlet										
										Shaft end options <b>01</b> = Straight with key (standard), <b>11</b> = Splined <b>86</b> = Heavy duty straight keyed, <b>90</b> = Splined SAE C

## Shaft options mm (inches)

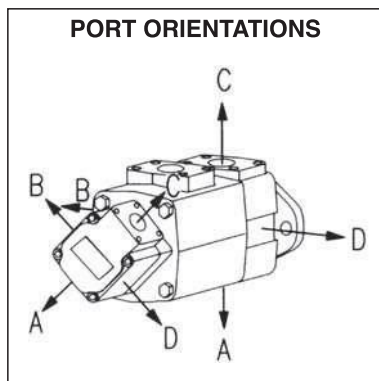
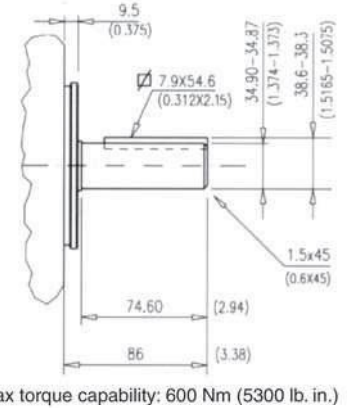
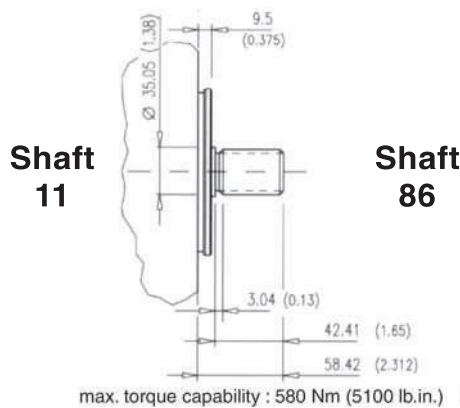
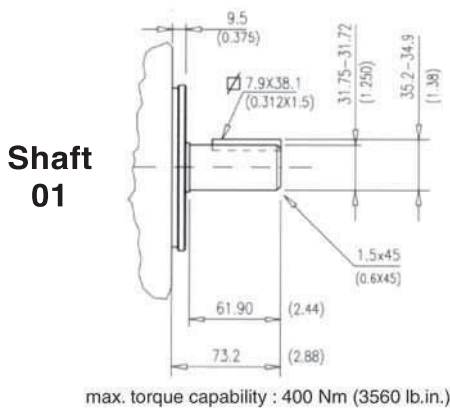

**Spline data**  
(shaft 11 and shaft 90)

Spline	Involute side fit (ASA B5.15)	
Pressure angle	30°	
No. of teeth	14	
Pitch	12/24	
Major dia.	31.60 - 31.50	(1.244 - 1.240)
Pitch dia.	29.634	(1.1667)
Minor dia.	26.99 - 26.66	(1.0627 - 1.05)
Wildhaber	15.68 - 15.73	(0.617 - 0.619)

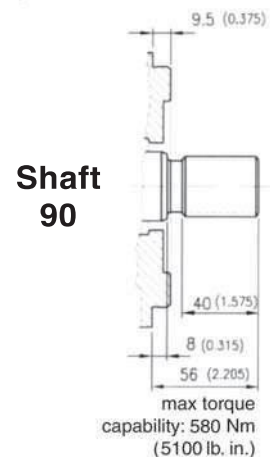

## Id. codes of pump components

Cartridges				Pump rotation	
cover end		shaft end			
Series	Model	Part No.	Series	Model	Part No.
V02	12	V0212010	V04	21	V0421030
	14	V0214050		25	V0425070
	17	V0217090		30	V0430110
	19	V0219130		35	V0435150
	21	V0221170		38	V0438190
V02	12	V0212020	V04	21	V0421040
	14	V0214060		25	V0425080
	17	V0217100		30	V0430120
	19	V0219140		35	V0435160
	21	V0221180		38	V0438200

Shaft kit	
Model	Part No.
01	M8420601
11	M8420611
86	M8420686
90	M8420690

Shaft		Key	
Model	Part No.	Part No.	Part No.
01	K4201000	M8040100	
11	K4211000	-	
86	K4286000	M8048600	
90	K4290000	-	

Body	
Part No.	M8040140

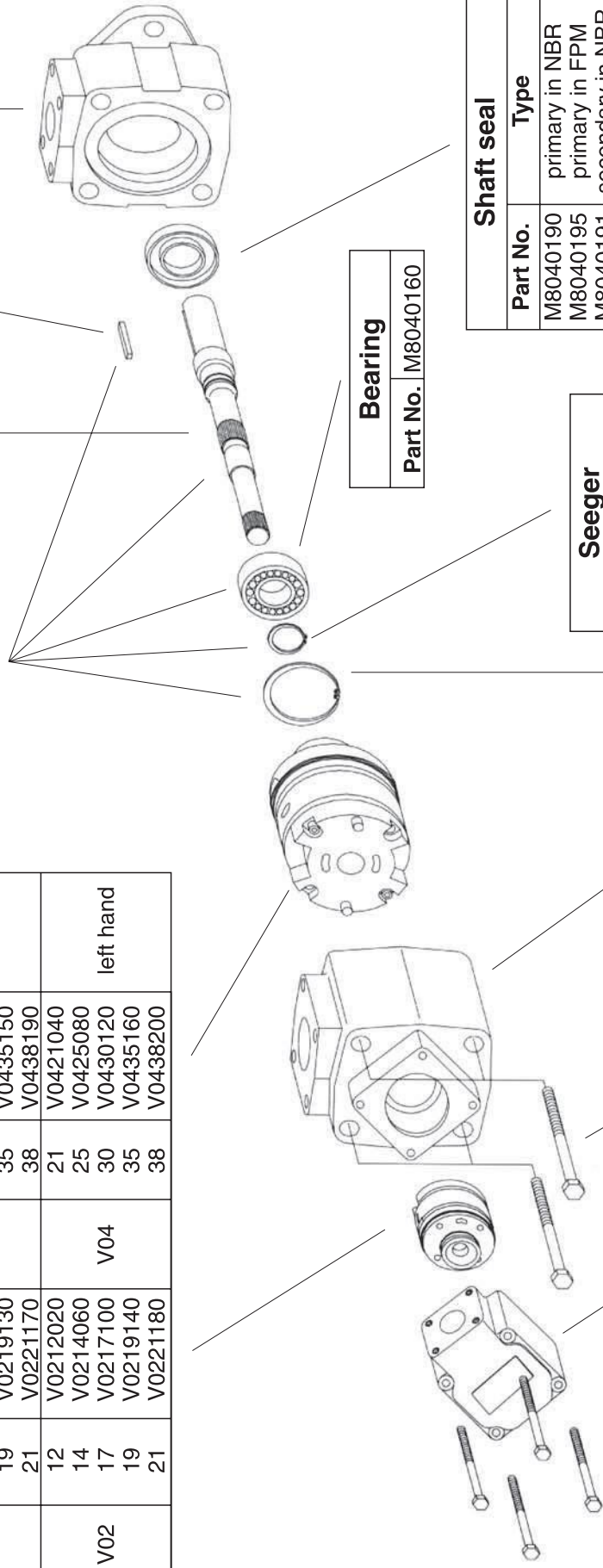

Bearing	
Part No.	M8040160

Seeger	
Part No.	M8040180

Shaft seal	
Part No.	Type
M8040190	primary in NBR
M8040195	primary in FPM
M8040191	secondary in NBR
M8040196	secondary in FPM

Intel body	
Part No.	M8040240

Cover	
Part No.	M8050350

Screw	
Part No.	M8040230
Torque to 102 Nm (910 lb. in.)	

Screw	
Part No.	M8040220
Torque to 225 Nm (2010 lb. in.)	

Seeger	
Part No.	M8040170

Pump seal kit		
Part No.	Parts	Type
M8420500	seals + 1 shaft seal	NBR
M8420501	seals + 2 shaft seals	NBR
M8420503	seals + 1 shaft seal	FPM (Viton®)
M8420504	seals + 2 shaft seals	FPM (Viton®)

## Operating instructions

**Maximum speed:** the maximum speeds given in this catalogue are valid for an atmospheric pressure of 1 bar (14.7 psi) and with ambient temperature in the range of +30°C to +50°C. Higher speeds than those given cause a reduction in the volumetric efficiency, due to cavitation phenomena in the inlet area inside the pump. Sustained excess speed causes a rapid deterioration of the internal components reducing the lifetime of the cartridge.

**Minimum speed:** In general, the min. speed for all pumps is 600 rpm. However, it is possible to operate at lower speeds with certain pump configurations and with appropriate operating temperatures.

**Inlet pressure:** the inlet pressure, measured at the inlet port, should remain within the prescribed limits. Note that pressures lower than minimum limit cause cavitation and pressures above the maximum limit cause abnormal loads on the shaft and the bearings. In both cases this causes a significant reduction in the lifetime of the cartridge.

**Maximum outlet pressure:** the maximum outlet pressure is different for each type of fluid used as can be seen from the corresponding diagrams. With optimal temperature and filtration conditions a pressure peak of +10% is permissible for a maximum time of 0.5 sec.

**Mounting and drive connections:** consider the following indications when preparing the installation drawings for the system:

- the pump is designed to operate with keyed shaft coupled axially and by means of a flexible coupling to the drive;
- the clearance between the keyed shaft and the corresponding sleeve coupling has to be between 0.004 and 0.030 mm;
- avoid axial and radial loads on the shaft;
- the mounting flange has to be perpendicular to the drive shaft, with a maximum error of 0.18 mm every 100 mm;
- when mounting onto a gearbox, or other component without a flexible coupling, it is advisable to order pumps with splined shaft. In this case the clearance between splines has to be between 0.013 and 0.051 mm on the pitch diameter.

**Hydraulic circuit:** always install a pressure relief valve on the supply line to prevent the pressure from exceeding the allowed maximum. Normally, it is set in accordance with the weakest component in the system. (In the case where it is the pump, set the valve to a pressure 15% higher than the maximum pressure rating of the pump.) Inlet line tubing should have a section equal to or greater than that of the inlet port of the pump. It is advisable to keep the tube connecting the pump to the reservoir as short possible. Particular care has to be taken with the inlet line which has to be hermetically sealed to avoid entraining air into the circuit; this varies the characteristics of the hydraulic fluid causing the operating parts to become damaged.

**Filtration:** the inlet line filter must have a flow rate capacity that is higher than that of the pump at its maximum operating speed. The filtration requirements for individual models are given in this catalogue. The use of a filter by-pass is recommended for cold starts and should the filter become clogged. Proper maintenance of the filter element is essential for the correct operation of the entire system. In normal conditions replace the filter element after the first 50 hours of operation. Subsequently, replace it at least every 500 hours. Regarding the filter on the return line, the same general conditions apply as for the inlet line and it should be positioned in an accessible location for ease of maintenance.

**Tank:** if possible, the reservoir should be positioned above the pump. Otherwise, ensure that the minimum level of the fluid contained in it is higher than the pump inlet line opening. It is important to avoid draining the inlet line with the pump at standstill. The opening of the return line into the reservoir must remain below the minimum level of the fluid in the reservoir. It must not be positioned too close to the opening of the inlet line to avoid the possibility of any air bubbles passing into the inlet line. Baffles inside the reservoir may be useful in avoiding the problem. Rapid temperature changes can cause condensation on the underside of the lid of the reservoir with the formation of droplets of water that can fall into the oil. To avoid this problem it is recommended that the lid should have small vents so that the air space in the reservoir is ventilated. The vents have to be screened, though, to prevent the entry of dust or the sudden expulsion of fluid.

**Start-up:** use the following procedure when the pump is started-up for the first time:

completely fill the pump and the inlet line with fluid;

start the engine for approximately one second a number of times at regular intervals of approximately 2 or 3 seconds until the noise level reduces, thereby confirming that it has been primed;

with a manometer check to ensure that the outlet pressure increases slightly;

once the pump has been primed, maintain low pressure levels activating all parts of the circuit a number of times until air bubbles disappear completely from the return line to the reservoir.

This procedure should be carefully as any residual air inside the pump can quickly cause the rotor to seize.

**Cold starting:** when starting the pump, especially with low ambient temperatures, operate with moderate speed and pressure until the average temperature in the entire circuit is within the given limits.

The information provided in this catalogue is subject to change without notice

COMPANY WITH  
QUALITY SYSTEM  
CERTIFIED BY DNV GL  
= ISO 9001 =

 **B&C**  
HYDRAULICS

[www.bcit.it](http://www.bcit.it)